

Operating Instruction

CHUCK 3 ZF ultra-short

Safety instruction

- Every chuck user should familiarise himself with this operating instruction.
- Stop the work immediately if the chuck functions incorrectly or is damaged.
- Avoid any hammer blows to the clamping jaws or other parts of the chuck.
- Bear in mind the clamping jaw ranges!
- Do not start the machine tool with the key/ split pin inserted.
- Only use original MAPROX spare parts.
- Ensure with all chucks that the entire jaw cogging meshes into the flat spiral.
- Key extensions can result in damage to the chuck.
- In addition to the safety instructions included in this operating instruction, the user is to follow the local safety regulations.
- Size and weight of the work piece are to be adjusted to the chuck or jaws in question.

Applications

- The chucks are used for clamping and/or processing workpieces on lathes, grinding, milling and measuring machines. They are also suited for deployment on dividers.

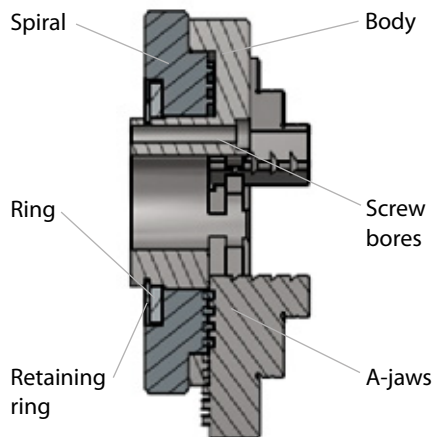

Fitting the chuck on the machine spindle

An adapter flange or a shank is used to install the chuck on the machine. The chuck is fitted on the adapter flange or shank once fitting has occurred on the machine spindle. Consult the drawing or the dimensions table on the right for the connection sizes.

Using the adapter flange or shank to install the chuck

Attach the chuck on the adapter flange or shank. Carefully tighten all the screws connecting the chuck with the flange/shank. Fit a dial gauge on the external diameter of the chuck body. Use a plastic-faced hammer to set the concentricity and then firmly tighten the fastening screws between flange/shank and chuck.

Installing the clamping jaws

DO NOTE. The clamping jaws are numbered (1, 2, 3). They are only to be fitted in the slideway with identical numbers.

Maintenance

The jaws, spirals and guides are to be regularly cleaned and greased. Machine oil or WD40, which also ensure smooth running, are suitable for using on measuring machines.

Original MAPROX replacement parts

- Stepped jaws A

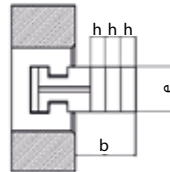
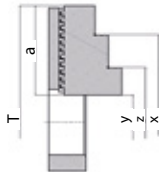

- Stepped jaws B

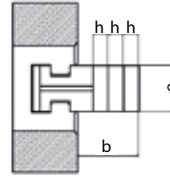
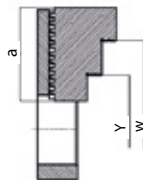

- Block jaws W

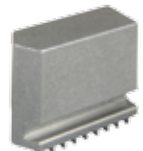
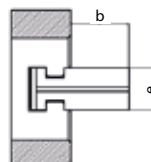
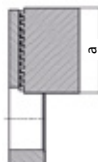

- Shank screws

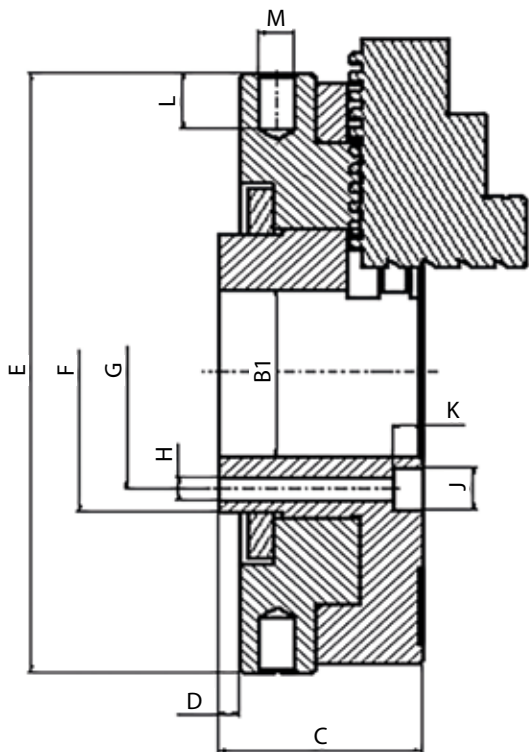

Dimensions table for chucks 3 ZF

3 ZF Ø	70	80	110	125	160	240
B1	18	22	32	36	46	68 (H7)
C	31	34	35	40	48.5	67
D	4	4	4	4	4	4
E	73	83	114	129	164	243
F 0 / +0.01	32	38	50	60	70	120
G	26	30	42	50	56	86
H	3 x 3.2	3 x 4.2	3 x 4.2	3 x 5.3	3 x 6.4	3 x 8.4
J	5.7	7.2	7.2	9.4	10.5	15
K	3.6	4.5	4.5	5.8	6.5	8
L	10	11	11	12	16	16
M	5	7	7	7	10	10
Travel Ø	36	41	64	73	90	112
Weight in kg, approx.	1.2	1.4	2.5	4.0	6.5	21.0
Permitted rotational speed	2800	2800	2500	2500	2000	1800

GUARANTEE CONDITIONS

We expressly refer you to our General Terms and Conditions at:
www.maprox.ch

