

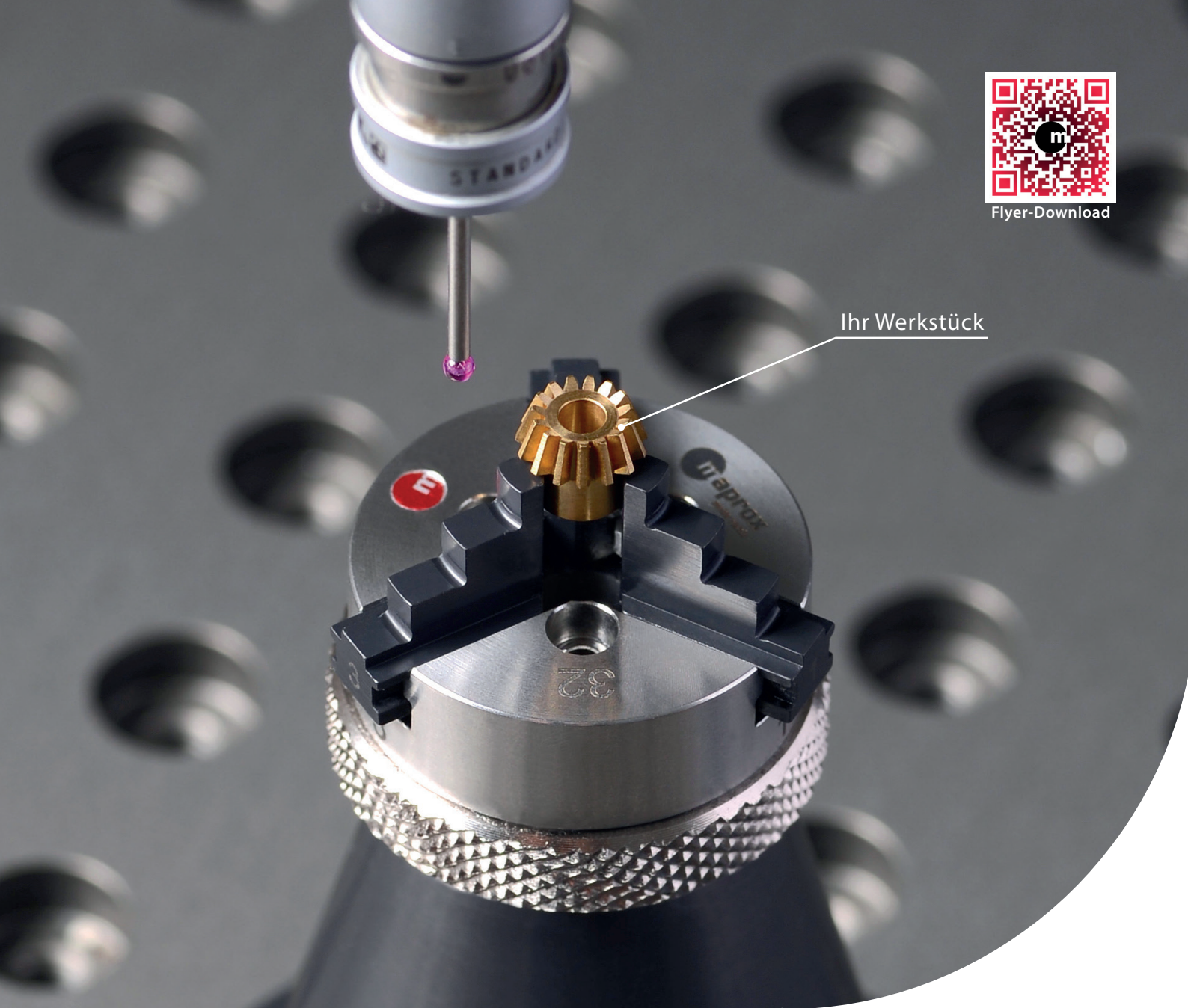

Flyer-Download



Ihr Werkstück

Spannfutter ZK Mini

Das kleinste und genaueste Spannfutter der Welt

- Innenspannung ab \varnothing 2 mm
- Wiederholgenauigkeit $\geq 10 \mu$
- Standard-, Sonder- und Spezialaufsatzbacken
- Rostfreier Edelstahl



3 ZK 30 mit/ohne Spannstift



3 ZK 45 ohne Spannstifte

Typ	Art. Nr.	Spannbereich [mm] ausßen - innen		Verfahrweg [mm] - Backen
3 ZK 30, ohne Spannstifte	10000.0110	0.6-34	6-34	9
3 ZK 30, mit Spannstiften	10000.0130	0.6-34	2-34	9
3 ZK 45, ohne Spannstifte	10000.0140	0.6-46	6-45	13

Technische Daten

- Aussendurchmesser: 30 mm (Körper)
- Durchgangs-Bohrung 8 mm
- Zulässige Drehzahl bis 6000 U/min.
- Auch für den Unterwassereinsatz, z.B. Drahterodieren (EDM)

- Korrosionsgeschützte (Reinox), geschliffene Aufsatzbacken
- **WICHTIG:** Ersatzbacken müssen auf Futter eingeschliffen werden, um die Genauigkeit zu gewährleisten
- Kompatibel mit diversen Adaptionen / Produkten

Masstabelle [mm]

3 ZK Ø	30	45
B1 Ø	8	22
C	20	34
D	3	4
E Ø	33	43
F Ø / +0.01 Ø	17	38
G Ø	13	30
H Ø	3 x 2.6	3 x 4.2
J Ø	4.6	7.2
K	3	4.5
Gewicht in kg, ca.	0.1	1.4

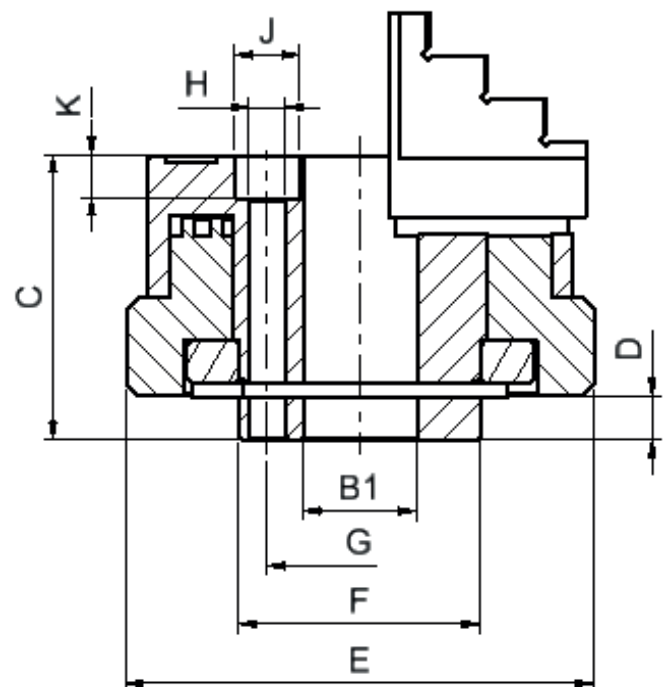

Backen, Typ A, B und W und A-Backen mit Stiften aus Federstahl

Stufenbacken Typ A

Typ A	Art. Nr.	a	b	e	h
3 ZKA 30	10000.0103	14	10	3	3
3 ZKA 45	10000.0103	14	10	3	3

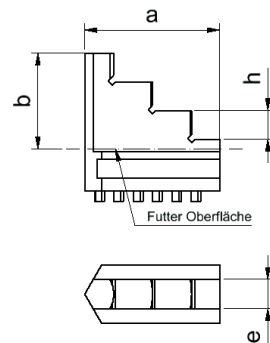
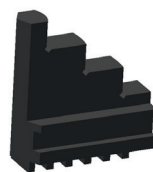

Stufenbacken Typ A mit Stiften aus Federstahl

Typ A	Art. Nr.	a	e	h
3 ZKA 30	10000.0120	0,7	Ø0.5	1,5
3 ZKA 45	10000.0120	0,7	Ø0.5	1,5

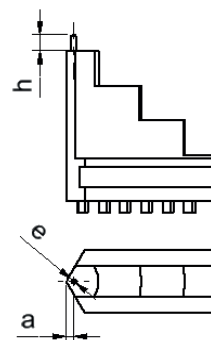
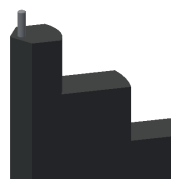

Stufenbacken Typ B

Typ B	Art. Nr.	a	b	e	h
3 ZKA 30	10000.0104	14	10	3	3
3 ZKA 45	10000.0104	14	10	3	3

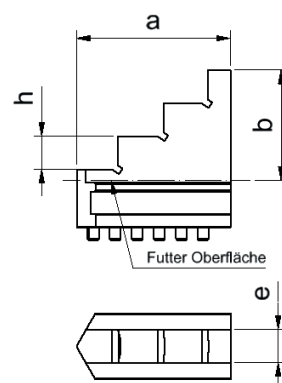
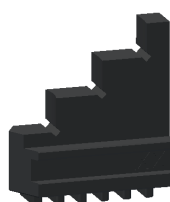

Backen Typ W - weich

Typ W	Art. Nr.	a	e	h
3 ZKA 30	10000.0108	14	10	3
3 ZKA 45	10000.0108	14	10	3

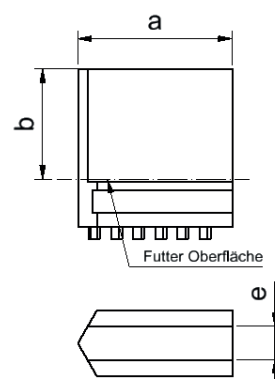

Ø 2 - 34 mm

3 ZK 30





3 ZK 30



Alex Keller
Sales & Engineering
Maprox AG
☎ +41 44 782 82 30



Dario Azzato
Head of Production
JKS Group
☎ +41 44 932 55 55



Laurent Gerber
Sales & Marketing
JKS Group
☎ +41 44 782 82 81



Maprox AG
Usterstrasse 87
CH-8620 Wetzikon
Tel: +41 (0)43 488 18 00
Fax: +41 (0)43 488 18 08
info@maprox.ch • www.maprox.ch

